



- **21.5% efficiency**

Ideal for roofs where space is at a premium or where future expansion might be needed.

- **Maximum performance**

Designed to deliver the most energy in demanding real world conditions, in partial shade and hot rooftop temperatures.^{1, 2, 3}

- **Premium aesthetics**

SunPower® Signature™ Black X-Series panels blend harmoniously into your roof. The most elegant choice for your home.

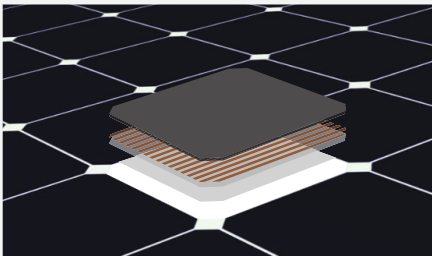

Moxeon® Solar Cells: Fundamentally better.

Engineered for performance, designed for durability.

Engineered for peace of mind

Designed to deliver consistent, trouble-free energy over a very long lifetime.^{4,5}

Designed for durability

The SunPower Moxeon Solar Cell is the only cell built on a solid copper foundation. Virtually impervious to the corrosion and cracking that degrade Conventional Panels.^{4,5}

Same excellent durability as E-Series panels.

#1 Ranked in Fraunhofer durability test.¹⁰

100% power maintained in Atlas 25+ comprehensive PVDI Durability test.¹¹

UNMATCHED PERFORMANCE, RELIABILITY & AESTHETICS

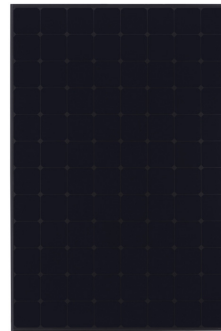

SIGNATURE™ BLACK
X21 - 335 PANEL

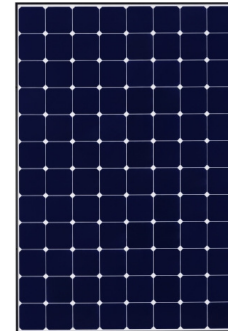

X21 - 345 PANEL



HIGHEST EFFICIENCY⁶

Generate more energy per square foot

X-Series residential panels convert more sunlight to electricity producing 44% more power per panel,¹ and 75% more energy per square foot over 25 years.^{3,4}

HIGHEST ENERGY PRODUCTION⁷

Produce more energy per rated watt

High year one performance delivers 8-10% more energy per rated watt.³ This advantage increases over time, producing 21% more energy over the first 25 years to meet your needs.⁴

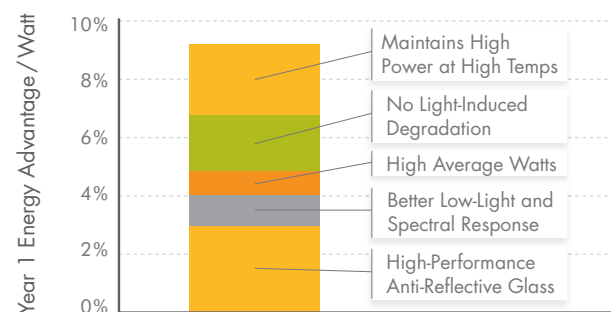
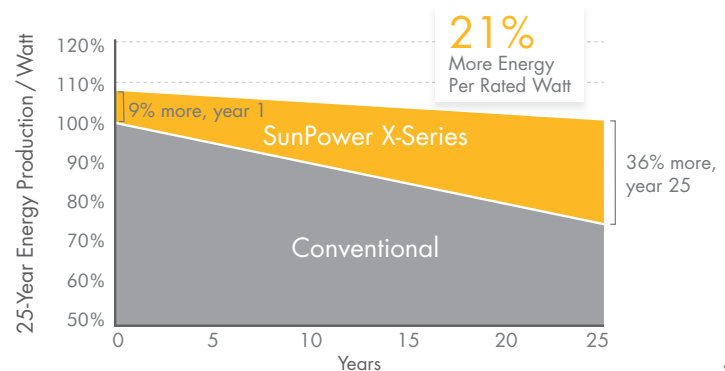

Awarded to SunPower E-Series. X-Series delivers even more energy.⁷

SUNPOWER OFFERS THE BEST COMBINED POWER AND PRODUCT WARRANTY

POWER WARRANTY

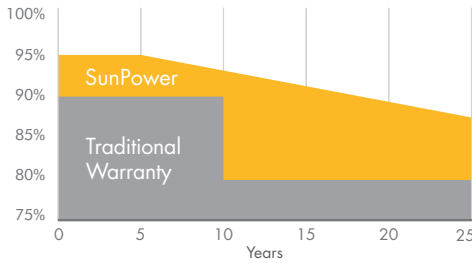

More guaranteed power: 95% for first 5 years, -0.4%/yr. to year 25. ⁸

PRODUCT WARRANTY

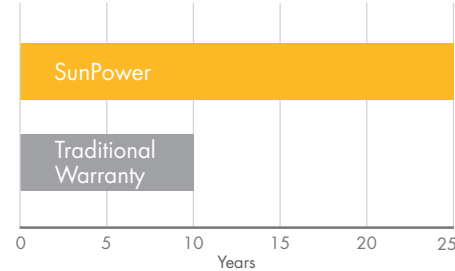

Combined Power and Product Defect 25 year coverage that includes panel replacement costs. ⁹

ELECTRICAL DATA

	X21-335-BLK	X21-345
Nominal Power ¹² (P _{nom})	335 W	345 W
Power Tolerance	+5/-0%	+5/-0%
Avg. Panel Efficiency ¹³	21.1%	21.5%
Rated Voltage (V _{mpp})	57.3 V	57.3 V
Rated Current (I _{mpp})	5.85 A	6.02 A
Open-Circuit Voltage (V _{oc})	67.9 V	68.2 V
Short-Circuit Current (I _{sc})	6.23 A	6.39 A
Maximum System Voltage	600 V UL ; 1000 V IEC	
Maximum Series Fuse	20 A	
Power Temp Coef. (P _{mpp})	-0.30% / °C	
Voltage Temp Coef. (V _{oc})	-167.4 mV / °C	
Current Temp Coef. (I _{sc})	3.5 mA / °C	

OPERATING CONDITION AND MECHANICAL DATA

Temperature	- 40°F to +185°F (- 40°C to +85°C)
Max load	Wind: 50 psf, 2400 Pa, 245 kg/m ² front & back Snow: 112 psf, 5400 Pa, 550kg/m ² front
Impact resistance	1 inch (25 mm) diameter hail at 52 mph (23 m/s)
Appearance	Class A+
Solar Cells	96 Monocrystalline Maxeon Gen III Cells
Tempered Glass	High Transmission Tempered Anti-Reflective
Junction Box	IP-65 Rated
Connectors	MC4 Compatible
Frame	Class 1 black anodized, highest AAMA Rating
Weight	41 lbs (18.6 kg)

TESTS AND CERTIFICATIONS

Standard tests	UL 1703, IEC 61215, IEC 61730
Quality tests	ISO 9001:2008, ISO 14001:2004
EHS Compliance	RoHS, OHSAS 18001:2007, lead-free
Ammonia test	IEC 62716
Salt Spray test	IEC 61701 (passed maximum severity)
PID test	Potential-Induced Degradation free: 1000V ¹⁰
Available listings	CEC, UL, TUV, MCS

REFERENCES:

- 1 All comparisons are SPR-X21-345 vs. a representative conventional panel: 240W, approx. 1.6 m², 15% efficiency.
- 2 PVEvolution Labs "SunPower Shading Study," Feb 2013.
- 3 Typically 8-10% more energy per watt, BEW/DNV Engineering "SunPower Yield Report," Jan 2013, with CFV Solar Test Lab Report #12063, Jan 2013 temp. coef. calculation.
- 4 SunPower 0.25%/yr degradation vs. 1.0%/yr conv. panel. Campeau, Z. et al. "SunPower Module Degradation Rate," SunPower white paper, Feb 2013; Jordan, Dirk "SunPower Test Report," NREL, Oct 2012.
- 5 "SunPower Module 40-Year Useful Life" SunPower white paper, Feb 2013. Useful life is 99 out of 100 panels operating at more than 70% of rated power.
- 6 Higher than E Series which is highest of all 2600 panels listed in Photon Int'l, Feb 2012.
- 7 1% more energy than E-Series panels, 8% more energy than the average of the top 10 panel companies tested in 2012 (151 panels, 102 companies), Photon Int'l, Mar 2013.
- 8 Compared with the top 15 manufacturers. SunPower Warranty Review, Feb 2013.
- 9 Some exclusions apply. See warranty for details.
- 10 X-Series same as E-Series, 5 of top 8 panel manufacturers were tested by Fraunhofer ISE, "PV Module Durability Initiative Public Report," Feb 2013.
- 11 Compared with the non-stress-tested control panel. X-Series same as E-Series, tested in Atlas 25+ Durability test report, Feb 2013.
- 12 Standard Test Conditions (1000 W/m² irradiance, AM 1.5, 25° C).
- 13 Based on average of measured power values during production.

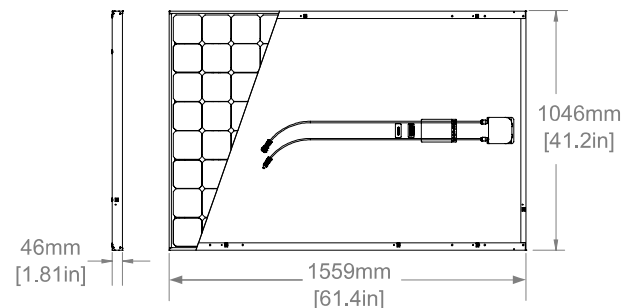

See <http://www.sunpowercorp.com/facts> for more reference information.

For further details, see extended datasheet: www.sunpowercorp.com/datasheets Read safety and installation instructions before using this product.