



# SunPower® E-Series Commercial Solar Panels | E20-327-COM

## Helix™ Roof Compatible Modules

Factory-installed clips enable tool-free panel installation, decreasing installation time and minimizing business disruption.<sup>1</sup>

## More than 20% Efficiency

Captures more sunlight and generates more power than conventional panels.

## High Performance

Delivers excellent performance in real-world conditions, such as high temperatures, clouds and low light.<sup>2,3,5</sup>

## Commercial Grade

Optimized to maximize returns and energy production, the E-Series panel is a bankable solution for commercial solar applications.

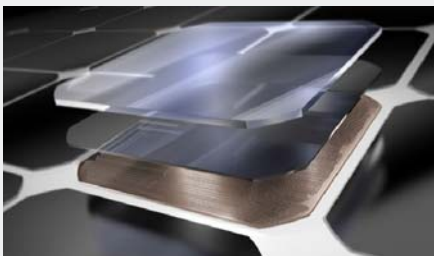

### Maxison® Solar Cells: Fundamentally better

Engineered for performance, designed for reliability.

## Engineered for Peace of Mind

Designed to deliver consistent, trouble-free energy over a very long lifetime.<sup>4,5</sup>

## Designed for Reliability

The SunPower Maxison Solar Cell is the only cell built on a solid copper foundation. Virtually impervious to the corrosion and cracking that degrade conventional panels.<sup>4</sup>

#1 Rank in Fraunhofer durability test.<sup>10</sup>

100% power maintained in Atlas 25+ comprehensive durability test.<sup>11</sup>

## High Performance & Excellent Reliability



SPR-E20-327-COM



## High Efficiency<sup>6</sup>

### Generate more energy per square foot

E-Series commercial panels convert more sunlight to electricity by producing 31% more power per panel<sup>2</sup> and 60% more energy per square foot over 25 years.<sup>2,3,4</sup>

## High Energy Production<sup>7</sup>

### Produce more energy per rated watt

More energy to power your operations. High year-one performance delivers 7-9% more energy per rated watt.<sup>3</sup> This advantage increases over time, producing 20% more energy over the first 25 years to meet your needs.<sup>4</sup>

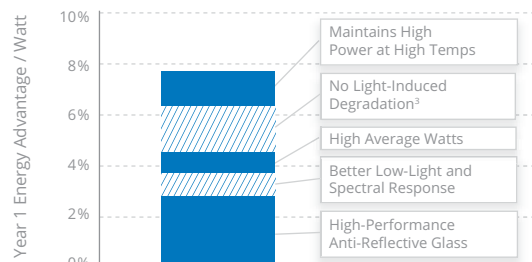
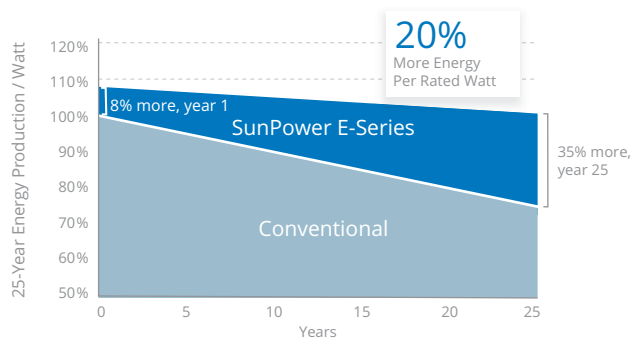



# SunPower® E-Series Commercial Solar Panels | E20-327-COM

## SunPower Offers The Best Combined Power And Product Warranty

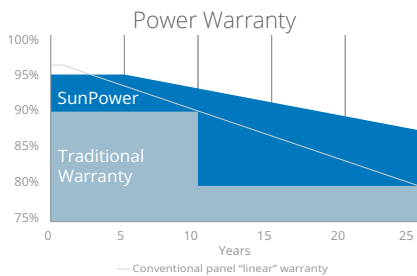

More guaranteed power: 95% for first 5 years,  
-0.4%/yr. to year 25<sup>8</sup>

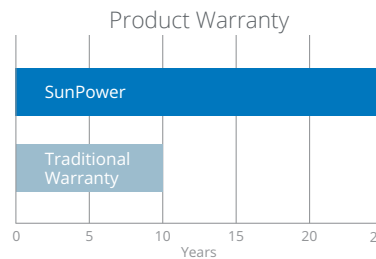

Combined Power and Product defect 25-year coverage<sup>9</sup>

### Electrical Data

	SPR-E20-327-COM	SPR-E19-310-COM
Nominal Power (P <sub>nom</sub> ) <sup>12</sup>	327 W	310 W
Power Tolerance	+5/-3%	+5/-3%
Avg. Panel Efficiency <sup>13</sup>	20.3%	19.3%
Rated Voltage (V <sub>mpp</sub> )	54.7 V	54.7 V
Rated Current (I <sub>mpp</sub> )	5.98 A	5.67 A
Open-Circuit Voltage (V <sub>oc</sub> )	64.9 V	64.4 V
Short-Circuit Current (I <sub>sc</sub> )	6.46 A	6.05 A
Max. System Voltage	1000 V UL & 1000 V IEC	
Maximum Series Fuse	15 A	
Power Temp Coef.	-0.35% / °C	
Voltage Temp Coef.	-176.6 mV / °C	
Current Temp Coef.	2.6 mA / °C	

### Tests And Certifications

Standard Tests <sup>14</sup>	UL1703 (Type 2 Fire Rating), IEC 61215, IEC 61730
Quality Certs	ISO 9001:2008, ISO 14001:2004
EHS Compliance	RoHS, OHSAS 18001:2007, lead free, REACH SVHC-163, PV Cycle
Ammonia Test	IEC 62716
Desert Test	10.1109/PVSC.2013.6744437
Salt Spray Test	IEC 61701 (maximum severity)
PID Test	Potential-Induced Degradation free: 1000 V <sup>10</sup>
Available Listings <sup>15</sup>	UL, TUV, JET, MCS, CSA, FSEC, CEC

### Operating Condition And Mechanical Data

Temperature	-40° F to +185° F (-40° C to +85° C)
Impact Resistance	1 inch (25 mm) diameter hail at 52 mph (23 m/s)
Appearance	Class B
Solar Cells	96 Monocrystalline Moxeon Gen II
Tempered Glass	High-transmission tempered anti-reflective
Junction Box	IP-65, TE (PV45)
Weight	41 lbs (18.6 kg)
Max. Load	Wind: 50 psf, 2400 Pa, 244 kg/m <sup>2</sup> front & back Snow: 112 psf, 5400 Pa, 550 kg/m <sup>2</sup> front
Frame	Class 2 silver anodized; stacking pins

#### REFERENCES:

- Helix-compatible modules may not be compatible with other racking systems.
- All comparisons are SPR-E20-327 vs. a representative conventional panel: 250 W, approx. 1.6 m<sup>2</sup>, 15.3% efficiency.
- Typically 7-9% more energy per watt, BEW/DNV Engineering "SunPower Yield Report," Jan 2013.
- SunPower 0.25%/yr degradation vs. 1.0%/yr conv. panel. Campeau, Z. et al. "SunPower Module Degradation Rate," SunPower white paper, Feb 2013; Jordan, Dirk "SunPower Test Report," NREL, Q1-2015.
- "SunPower Module 40-Year Useful Life" SunPower white paper, May 2015. Useful life is 99 out of 100 panels operating at more than 70% of rated power.
- Second highest, after SunPower X-Series, of over 3,200 silicon solar panels, Photon Module Survey, Feb 2014.
- 7.8% more energy than the average of the top 10 panel companies tested in 2012 (151 panels, 102 companies), Photon International, Feb 2013.
- Compared with the top 15 manufacturers. SunPower Warranty Review, May 2015.
- Some restrictions and exclusions may apply. See warranty for details.
- 5 of top 8 panel manufacturers tested in 2013 report, 3 additional panels in 2014. Ferrara, C., et al. "Fraunhofer PV Durability Initiative for Solar Modules: Part 2". Photovoltaics International, 2014.
- Compared with the non-stress-tested control panel. Atlas 25+ Durability test report, Feb 2013.
- Standard Test Conditions (1000 W/m<sup>2</sup> irradiance, AM 1.5, 25° C). NREL calibration Standard: SOMS current, LACCS FF and Voltage.
- Based on average of measured power values during production.
- Type 2 fire rating per UL1703:2013, Class C fire rating per UL1703:2002.
- Only SPR-E20-327-COM has MCS certification.

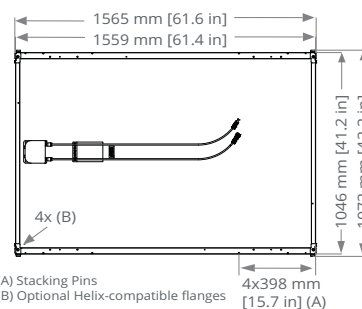

#### FRAME PROFILE

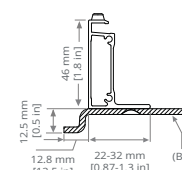

(A) Stacking Pins  
(B) Optional Helix-compatible flanges

Please read the safety and installation guide.  
Clips installed on Helix Roof compatible modules only.  
Clips are not removable and may not be compatible with non-Helix-branded racking.

See [www.sunpower.com/facts](http://www.sunpower.com/facts) for more reference information.  
For more details, see extended datasheet: [www.sunpower.com/datasheets](http://www.sunpower.com/datasheets).

Document # 515662 Rev D /LTR\_US